

**F 101** 52x66/52x80 EASY LOCK catena - chain

**SERIE F - F SERIES**

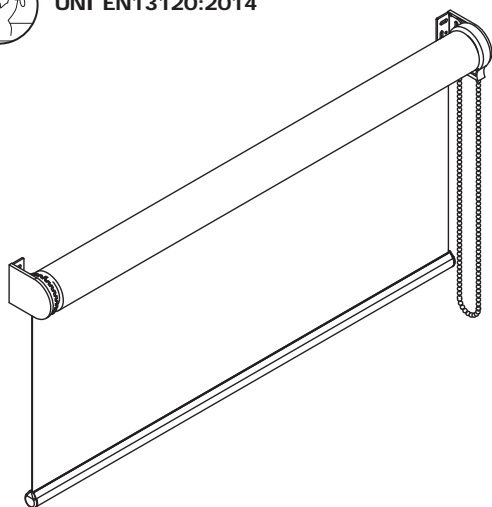
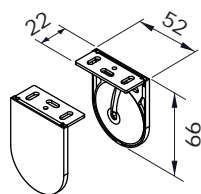

UNI EN13120:2014

 dimensioni in mm  
 dimensions shown in mm

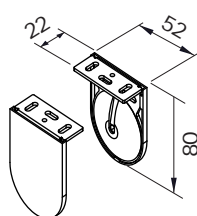
52x66

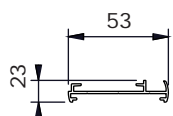
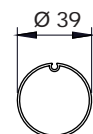

52x80

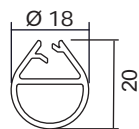

 profilo di premontaggio  
 aluminum frame

rullo - tube

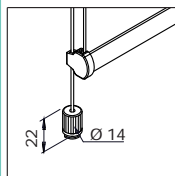

F21 Serie 2012

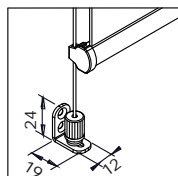
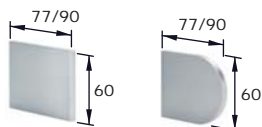
**varianti - optional**

 fondale FR23 e cavo perlon  
 $\Phi 1,2$ mm con tenditore per  
 fissaggio piano orizzontale,  
 con staffe in acciaio per piano  
 verticale

 FR23 hem bar and  $\Phi 1,2$ mm  
 perlon cable with cable  
 tensioning block for window  
 sill/floor mounting or brackets  
 for wall mounting

 copri staffe magnetici in  
 alluminio satinato  
 satin finish aluminium  
 magnetic bracket covers.

**CARATTERISTICHE:**
**Tipo di applicazione:** verticale

**Ambiente di applicazione:** interno

**Staffe di fissaggio:** 52x66 mm in ferro verniciato con copri staffe in PVC (bianco, nero, grigio); staffa 52x80 mm su richiesta. A supplemento copri staffe magnetici in alluminio satinato.

**Rullo di avvolgimento:**  $\Phi 39$  mm in alluminio estruso con ogiva per facilitare la manutenzione del telo

**Fondale:** F21 Serie 2012 in alluminio estruso con tappi in PVC. Fondale FR23 con la variante guida cavo perlon.

**Manovra:** a catena con comando frizionato EASY LOCK in PVC completo di calotta lato opposto con perno rientrante per facilitare lo smontaggio del rullo dalle staffe. Catena passo 6 in nylon con grani in PVC  $\Phi 4,5$  mm dotata di sgancio di sicurezza "child safety device" secondo la norma UNI EN13120:2014

**Fissaggio:** a parete o a soffitto. A supplemento profilo di premontaggio in alluminio estruso verniciato (bianco Ral 9010 - nero Ral 9005 opaco - argento anodizzato)

**CHARACTERISTICS:**
**Application:** vertical

**Installation:** indoors

**Brackets:** 52x66 mm steel powder coated brackets with PVC covers (white, grey, black), 52x80 mm on request. Supplement for satin finish aluminium magnetic bracket covers.

**Roller tube:**  $\Phi 39$  mm extruded aluminum tube with slot to facilitate fabric removal

**Hem bar:** F21 Serie 2012 extruded aluminum hem bar with PVC caps. FR23 hem bar supplied with guided blind with cable.

**Operation:** EASY LOCK chain operation. Opposite side end plug with retractable pin to easily remove the tube from the brackets.  $\Phi 4,5$  mm PVC/nylon bead chain, 6 mm pitch, with incorporated child safety device - UNI EN13120:2014

**Mounting:** wall or ceiling. Supplement for powder coated premounting frame (white Ral 9010 - matt black Ral 9005 - silver anodised)

**note - notes**

 fondale in alluminio estruso FR23 in abbinamento alla variante con cavi  
 guided blind with cables supplied with FR23 extruded aluminium hem bar

 idonea per tessuti leggeri (fino a 350 g/m<sup>2</sup>)  
 suitable for lightweight fabrics (upto 350 g/m<sup>2</sup>)

**colori standard - standard colours**

bianco Ral 9010 - white Ral 9010

avorio Ral 1013 - ivory Ral 1013

marrone Ral 8017 - brown Ral 8017

nero Ral 9005 opaco - matt black Ral 9005

argento anodizzato - silver anodised

**tessuti abbinabili - suitable fabrics**

 per l'utilizzo dei tessuti consultare la sezione dei teli confezionati e/o Tabella "A"  
 for fabric choice consult the fabric section and Tab. "A"

**supplementi - supplement**
